

CERAGEM

 **CERAGEM CO., LTD.**
10, Jeongja 1-gil, Seonggeo-eup,
Seobuk-gu, Cheonan-si, Chungcheongnam-do,
31045, Korea
Tel : 82-41-523-2550 Fax : 82-41-523-2560

CERAGEM
MASTER V6

User Manual | CGM MB-1701

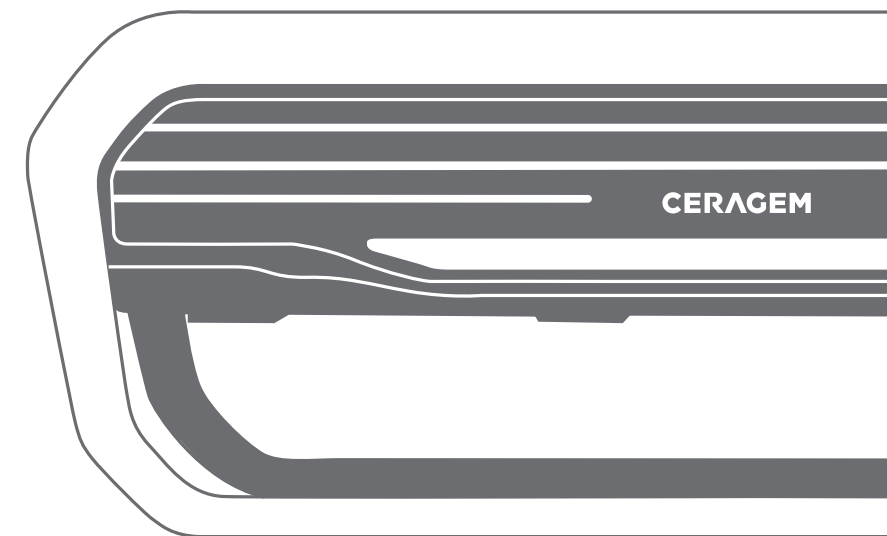

E6NON107030 JAN/13/22



Warnings and safety information

This appliance is not intended for use by persons (including children) with reduced physical, sensory or mental capabilities, unless they have been given supervision or instruction concerning use of the appliance by a person responsible for their safety. Children should be supervised to ensure that they do not play with the appliance. The information below stands to protect the safety of the user and to prevent any property damage. All users must read the manual and use the product appropriately. The "Warnings and safety information" are divided into "Danger", "Warning" and "Caution" and their meanings are as follows. These symbols indicate potentially dangerous situations or control methods.



Danger

In case of violating the instructions, there is an emergent possibility of serious damage or even death.



Warning

In case of violating the instructions, there is some possibility of serious injury or death.



Caution

In case of violating the instructions, there is possibility of minor injury or property damage.

SAFETY WARNING!

The bed should not be used by persons exceeding 298lb/135kg in weight.



Danger

Unintended use may cause burns or physical harm.

Please follow the instructions carefully in order to reduce potential electric shocks.

1. While using this product, do not remove all metal accessories, jewelry, or other items from your body.
2. Please check the frame before use. If there are any signs of cracks, breaks or expiration, stop using the product.
3. Do not use the product in humid or wet conditions.
4. Burn Hazard: the external projector must be used with the corresponding cover to prevent direct contact between the product and skin. There is a risk of receiving burns.
5. To prevent damage to the eye (eyeball), do not place the external projector directly on the eye.
6. In case of thunder, lightning or an earthquake, please stop using the product and unplug it. (There is risk of receiving an electric shock or a burn.)
7. Do not pull the cord to unplug or touch the power plug with wet hands. (There is risk of receiving an electric shock or a burn.)
8. Apart from the mode for massaging the abdomen or the manual mode, do not use the product laying face down. (If the product is used lying down, do not use near the rib cage and only on the abdomen.)
9. The patient is an intended operator.

Warnings and safety information



1. Only use the product if it is in mechanically complete condition.
(If damaged products are used, there is a possibility of injury or burns.)
2. If you have finished using the product or will not use it for a long time, unplug the product.
3. Apart from the external projector cover provided by our company, do not place other products or substances on top that may cause fires (such as fiber products, blankets, etc.)
(Overheating can cause fires and electric shocks.)
4. In case of use by a disabled person or children, guardians must be present.
*Warning! Keep children away from where this product has been installed.
*Warning! Make sure that children do not jump on the thermal massage bed.
5. Do not use the product if they are in the conditions mentioned below. Call the customer center and request inspection or after-service.
 - If the product has been dropped or is damaged
 - If the product is wet
 - If the cord or the power button is damaged. (There is a risk of an electric shock or a fire.)
6. Keep the power cord away from electric heating appliances or heaters.
7. This product has only been designed for indoor use. Do not use it outdoors.
8. Do not use the product where there are foreign substances in the air or places that handle oxygen.
9. Do not use or apply skin care, cosmetic or medical products on your skin before and during the use of this product.
10. When dismantling the product, make sure both the remote control and the main system are switched "Off" before unplugging.
11. Be cautious of heated surfaces. (Can cause severe burns.)
12. Do not use the external projector on parts of the body that have low levels of sensitivity or parts that have reduced blood flow.
(The heat remaining from the product may be dangerous to children or those who are in poor health.)
13. Please do not sleep on the equipment.
14. Do not randomly disassemble, repair, or remodel the product. Call the customer center when in need of a repair.
(There is a risk of electric shock, fire, injury, and/or burns.)
15. Please take care not to insert your hand or any other body part into the main equipment or supporting mat. (There is a risk of electric shock and/or injury.)
16. To avoid the risk of injury:
 - Pregnant women, people who have malignancies, high fever, osteoporosis, people in poor physical health, people in poor physical shape or undergoing any medical treatment, and people suffering back, neck, shoulder or hip pain should consult their doctor before using the product.
 - If you have a pacemaker, defibrillator, other artificial implants or other medical devices, consult with your doctor prior to use.
 - If you have sensitive reactions or allergy to heat, you should also consult your doctor before using the product.

Warnings and safety information

- Do not use on bare skin; always wear clothing while using the product.
 - Do not use if you have had any major surgeries, including back and/or hip surgeries.
 - Consult your doctor prior to use if you have any external wound(s) or infection(s) on the skin where the product will come into direct contact with your skin.
 - Immediately stop using the unit if you start to feel sick or uncomfortable, or if the massage seems too painful.
 - As of now, there is no evidence to suggest that this product interferes with or influences medications. Those taking any prescribed medications should consult their doctor before using this product.
 - Do not go to sleep while using the unit.
 - Do not use the unit after drinking alcohol.
 - Do not allow children or pets to play on or around the unit, especially during operation.
 - Consult with your physician before using the product if you suffer from circulatory insufficiency or weak circulation in legs or heart diseases.
 - Consult with your physician before using the product if you suffer from pain of unidentified cause.
17. Using the cable incorrectly may lead to strangulation. Please be careful.
 18. Please keep RFIDs and cellphones 20cm/8 in from the device.



1. When using the internal projector, keep your body straight; do not twist your body.
2. When the product is set to high temperatures, there is a risk of burns, so set the projector's temperature at an optimal level. (Depending on the physical constitution or thickness of skin, use the product at optimal temperature.)
3. Those with sensitive skin must use the product at lower temperatures. (There is a risk of burns)
4. Children, those who cannot control the temperature by themselves, and those who have weak sensory skin must be cautious of using the product for an extended period even if it is set at a low temperature because there is risk of receiving a burn.
(Warning! Please use while wearing clothing.)
5. If there are any abnormal symptoms while using the product, you must consult a doctor before using it again.
6. Do not bend the power cord or the outer wiring by force.
(There is a risk of electric shocks and fires.)
7. Do not place flammable objects (candles, cigarettes and alcohol), objects with water in them, heavy objects, or sharp objects on top of the product.
(They can cause electric shocks and damage.)
8. When climbing on or off the product, be cautious of the risk of falling.
9. Use according to the instruction manual and do not exceed the duration and methods instructed in the manual.
(Use 1~2 times a day and do not use other products unless supplied by the manufacturer.)

Warnings and safety information



Caution

10. Do not use the external projector(s) for more than 2~3 minutes on one part of the body.
(The projector must be moved to another part of the body after 2~3 minutes.)
11. Do not apply shock to the product.
12. Do not close the supporting mat or detach the remote control during use.
(The active mode is automatically terminated.)
13. The appliance has a heated surface. Persons insensitive to heat must be careful when using the appliance.
14. Please take care not to spill any foreign substance in between the main equipment and the supporting mat.
(It can cause electric shock, fire, injury, and/or equipment failure.)
15. Please do not throw the remote control or pull on the connecting cable.
(It can cause injury and equipment failure.)
16. The device must not be located in a location where it is hard to remove the detachable power plug.
17. When a set period of time has passed after setting the mode, the internal projector will move automatically. Lie down in the appropriate body position (as shown next page).
18. Do not pull or throw the air cell massager parts forcefully.
19. Do not twist the air hose of the air cell massager.
20. If the pressure is too strong when using the air cell massager, stop using the product immediately.
21. Sticking a sharp object into air cell massager parts may cause malfunction.
22. A level of noise may be heard while the air cell massager is operating.
23. If the pressure when using the air cell massager differs significantly from that felt during previous use, contact the customer service center.
24. Do not wash or soak the air cell massager/air massage module in water.
25. Wipe the air cell massager/air massage module gently with a wet cloth or towel.
26. When sitting or lying down on the product, the product senses body shape automatically and the internal projector may move.
27. Data in the USB memory may be damaged while using the product.
Store important data on a separate device.
(Ceragem is not responsible for any loss of data).
28. Twisting may occur due to the characteristics of the remote control cable component, so check its condition after using the product.
(If the cable is twisted, it may be difficult to store.)
29. Be sure to fully open or close the supporting mat before use.
(Applying a load without fully opening or closing the supporting mat may cause product damage or failure.)
30. Do not connect more than one electrical product into the same outlet.
31. When using the product in the abdominal area, avoid using it in the rib area.
32. This product is not a processed product under the act on Protective action guidelines against radiation in the natural environment.

Warnings and safety information

Proper body position for use

- 1) Extend the device by pulling the supporting mat as shown below.

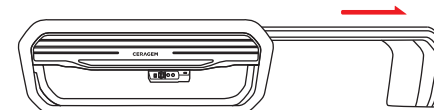

- 2) Lay your body on the device as shown below.

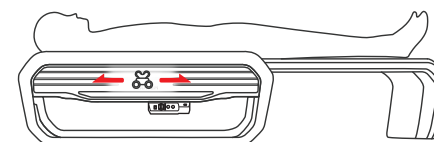

- 3) Align the user's head with the logo on the top of the device. (marked with a circle)

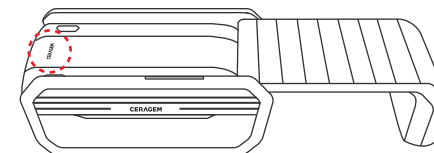

※ Important information on symptoms

Persons with pre-existing conditions (i.e. spinal conditions, distinct hypertension, high blood pressure, cardiovascular disease, dizziness, etc.) should moderate massage intensity, temperature, duration, and frequency of use. If adverse reactions are encountered during or immediately following use, immediately stop use and consult your physician.

User must report a suspected medical device-related serious injury to both the authority and manufacturer.

Also, if user encounters a situation that user consider to be an adverse event when using the device, user should also report it to the authorities and manufacturer.

This device is designed for home use.

Notice to users

This device complies with Part 15 of the FCC Rules. Operation is subject to the following two conditions: (1) this device may not cause harmful interference, and (2) this device must accept any interference received, including interference that may cause undesired operation.

NOTE: This equipment has been tested and found to comply with the limit for a Class B digital device, pursuant to Part 15 of the FCC Rules. These limits are designed to provide reasonable protection against harmful interference in a residential installation. This equipment generates, uses and can radiate radio frequency energy and, if not installed and used in accordance with the instructions, may cause harmful interference to radio communications. However, there is no guarantee that interference will not occur in a particular installation, which can be determined by turning the equipment off and on, the user is encouraged to try to correct the interference by one or more of the following measures:

- Reorient or relocate the receiving antenna.
- Increase the separation between the equipment and receiver.
- Connect the equipment into an outlet on a circuit different from that to which the receiver is connected.



Caution

Changes or modifications not expressly approved by the party responsible for compliance could void the user's authority to operate the equipment.

Contents

ⓘ Warnings and safety information	01
- Danger	
- Warning	
- Caution	
I. Introduction to the Master V6	07
1. Indications for use	
2. Product features	
3. Parts and components	
II. Installation and preparation	11
1. Check product components	
2. Before installation	
3. Installation	
4. After installation	
III. Using the Master V6	17
1. Before using the product	
2. Remote control layout	
3. Using the remote control	
4. Moving the product	
IV. Maintenance and troubleshooting	41
1. User checklist (Before & After use procedure)	
2. Maintenance and storage	
3. Troubleshooting	
4. Diagnostic codes	
5. Product specifications	
V. Service Manual	49

I . Introduction to the Master V6

1. Indications for use
2. Product features
3. Parts and components

1. Indications for use

The intended use of the Ceragem Automatic Thermal Massager Model CGM MB-1701 is to provide muscle relaxation therapy by delivering heat and soothing massage. Additionally, the product provides topical radiant infrared heat for:

- Temporary relief of minor muscle and joint pain stiffness
- Temporary relief of minor joint pain associated with arthritis
- Temporary increase in local circulation where applied
- Relaxation of muscles

The Air Cell Massager is indicated for the temporary relief of minor muscle aches and pains and for temporary increase in blood circulation to the treated areas.

The Air Cell Massager stimulates kneading and stroking of tissues by using an inflatable garment.

2. Product feature

New



Specialized 3D motion internal heating projector
The pressure to the cervical vertebral is reinforced and optimized 3D motion close massage is provided along the spine.

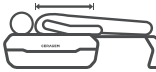

Functions customized to the body shape of the user
The length and curve of the spine are measured precisely and a customized massage that suits the body shape of each user is delivered.

New



Air cell massager
Low-noise air cell massager that helps blood circulation (air massage apparatus)

Upgrade



22 massage modes
Select a massage that fits the body condition through 17 automatic modes, semi-automatic mode, manual mode, and master mode.

New



Adjustment of speed at three levels
Enhanced feeling of massaging effectiveness through the massage speed adjustment function for slow or fast operation.

New

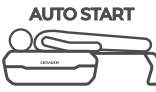

AUTO START
Auto start
When the user lies down with the product turned on, the massage begins automatically through the weight detection sensor.

New



EASY SLIDING
Easy sliding
Convenient sliding function through auxiliary wheels integrated with the actuator technology.

3. Parts and components

* Design (color) and the cover pattern may vary according to the product.

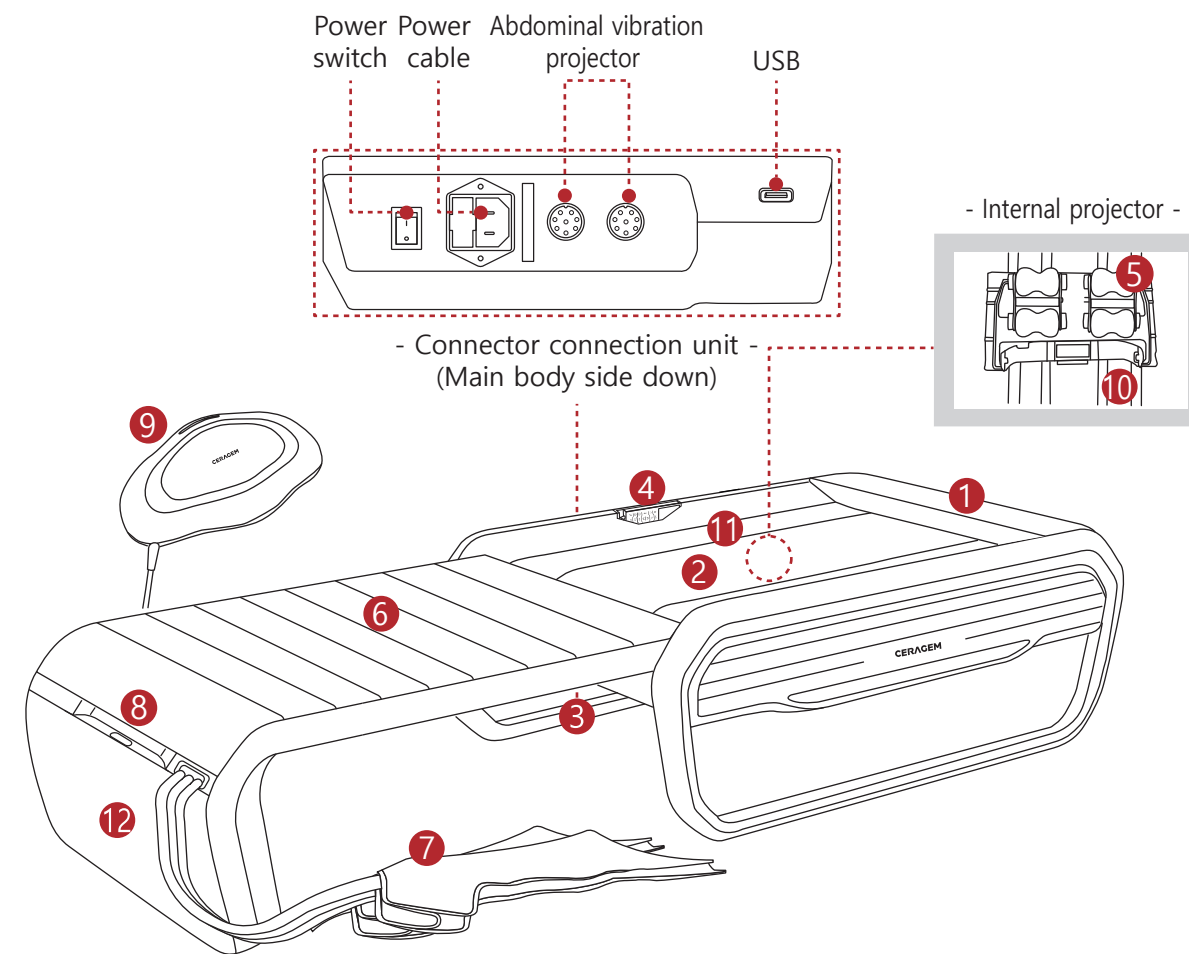

1	Head cushion	7	Air cell massager(Applied part)
2	Outer fabric	8	Sliding handle
3	Power switch(Main body side down)	9	Abdominal vibration projector (Heating element, applied part)
4	Remote control(Wired cable)	10	Internal heating element (Heating element)
5	Internal projector(Heating element)	11	Main mat
6	Supporting mat (Heating element, applied part)	12	Accessory storage Box

MEMO

A series of horizontal dashed lines providing a template for handwritten notes.



II. Installation and preparation

- 1. Check product components
- 2. Before installation
- 3. Installation
- 4. After installation

1. Check product components

1	Main body Use it lying down as a device that helps relieve muscle pain.
2	Abdominal vibration projector This can be connected to the main body and used on the abdomen.
3	Abdominal vibration projector cover Can be used to cover the abdominal vibration projector.
4	Remote control Used to check the product functions and operating condition of the product.
5	Remote control back label Explanation of the buttons on the remote control (attaches to the back of the remote control).
6	Power cord Connects with the main body and plugs into an outlet for use.
7	User manual Explains use of the product.
8	Outer fabric Protects against product contamination and burns; this detachable fabric makes washing easy.
9	Head cushion This is attached to the top of the product.
10	Assembly guide Product assembly methods are described.
11	Air cell massager It helps blood circulation and is worn on the legs.
12	Waterproof cover Use the waterproof cover to protect your product when transporting or storing.
13	Rug To protect the product and floor, you can put it under the main body and use it

2. Before installation

- 1 Install where the ground is flat to avoid the risk of damaging the product.
- 2 Try and avoid installation where there is a lot of humidity or dust.
(To avoid risking electric shocks or fire.)
- 3 Install according to the designated order.
- 4 Do not drop the product or apply any force to it.
(This could cause malfunctioning.)
- 5 Please check the rated voltage(100-127V~.) when installing the product.
(This can also cause circuit breakage and fire.)
- 6 Do not use old outlets and damaged power cables or plugs.
(There is a risk of electric shock.)
- 7 After you purchase the product, a professional installation technician will install it. Do not assemble or disassemble the product yourself.

3. Installation

* After you purchase the product, a professional installation technician will carry out the basic assembly process.

1 Remove the product and its components from the box.

2 Check and connect the abdominal vibration projector correctly.
(Insert the connector correctly and fix it properly by turning the fixture.)

3 Remove the film from the LCD and the keypad on the remote control.

4 Connect the power cord to the main body first and plug the power cord into an electrical outlet.

4. After installation

1 Turn on the power (located at the bottom of the main body).

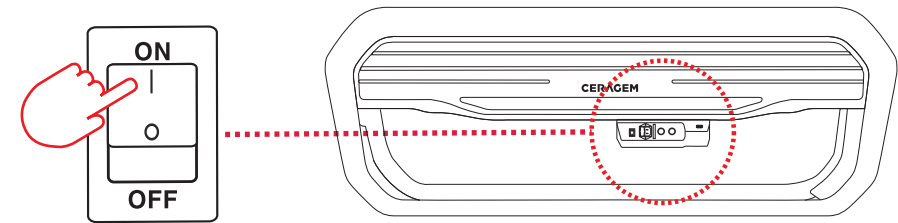

2 Press the POWER button on the remote control and check that the screen turns on.



* When power is supplied to the main body, the LED on the side of the remote control turns on, and when the remote control turns on, the LED will turn off.

* Refer to Page 21 for the screen of the remote control.



Caution

1. Set the correct temperature for each user.
2. Sit on or use the product after opening the supporting mat to its end.

4. After installation

When using the air massage

When assembling the air cell massager, insert it into the insertion hole with the arrow on the connection unit pointing up.

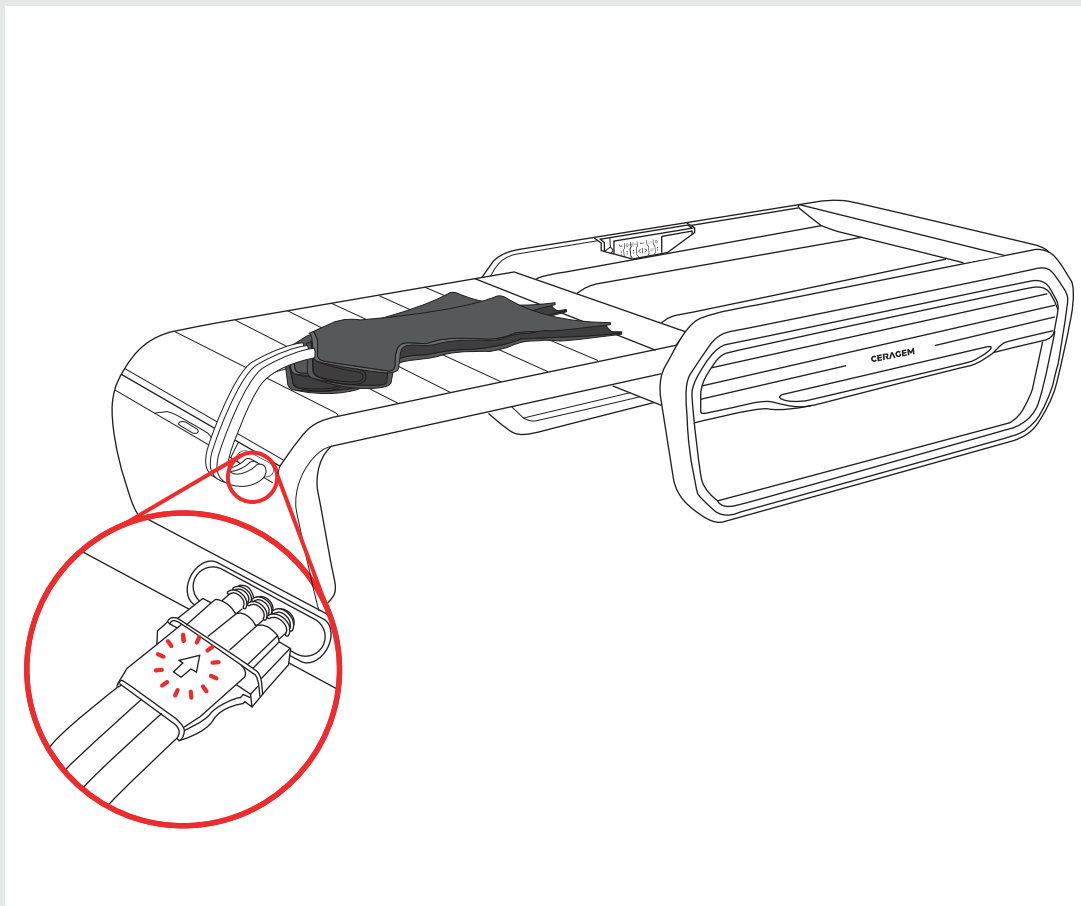

Caution

- When using the air massage, do not sit on or lean against the supporting mat.
- Be careful not to fold the air hose. (Product failure may occur.)

III. Using the Master V6

1. Before using the product
2. Remote control layout
3. Using the remote control
4. Moving the product

1. Before using the product

Using the product correctly

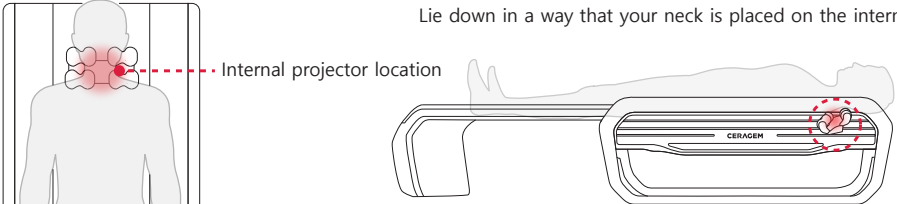

Lie down in a way that your neck is placed on the internal projector.

Internal projector location

Wait!
If you do not lie down correctly, the body icon may not appear on the remote control screen. This is not a product failure. Press the mode start button and use the product immediately.

Abdominal vibration projector connection

1 Connect the abdominal vibration projector to the main body.
(Insert the connector correctly and fix it by turning the fixture.)

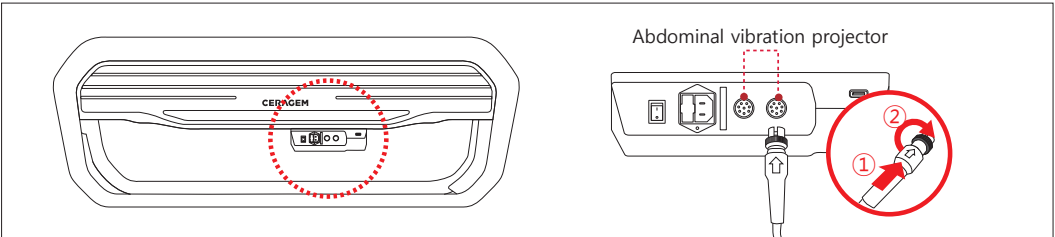

2 After turning on the main body, check if the abdominal vibration projector icon is displayed on the screen of the remote control.

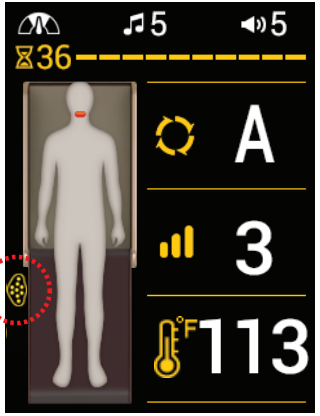

Wait!
- Before using the product, check if the abdominal vibration projector is connected correctly. (The image is displayed on the remote control only when the abdominal vibration projector is connected.)

2. Remote control layout

Composition of buttons on the remote control



- Power On/Off button
- Intensive mode button
- Manual mode button
- Temperature select button
 - Internal projector
 - Abdominal vibration projector
 - Main mat, supporting mat
- Control button
 - Massage speed control : press and hold
- All mode Start/Pause button
- Automatic mode button (Automatic A, 1~16)
- Semi-automatic mode button
- Strength select button (1~9)
- Abdominal vibration projector mode (1~3)/Strength (1~3) (Selection and control)
- Air massage mode(1~3)/Strength(1~9) (Selection and control)
- Sound selection/Volume (Selection and control)

Automatic mode

- Mode A(Standard)
- Mode 1(Special)
- Mode 2(Relax)
- Mode 3(Stable)
- Mode 4(Circulation)
- Mode 5(Basic health)
- Mode 6(Energy)
- Mode 7(Study)
- Mode 8(Rest)
- Mode 9(Body line)
- Mode 10(Stretching)
- Mode 11(Growth)
- Mode 12(Golf)
- Mode 13 (Meditation-Golf)
- Mode 14 (Meditation-Relax)
- Mode 15 (Meditation-Stable)
- Mode 16 (Meditation-Breathing)

Selection mode

- Intensive mode
- Manual mode
- Semi-automatic mode

Button layout

Back label

Wait!

- Mode, Start/Pause, and Strength can be adjusted only when the abdominal vibration projector is connected.
- Mode, Start/Pause, and Strength can be adjusted only when the air massage is connected.

2. Remote control layout

Screen display

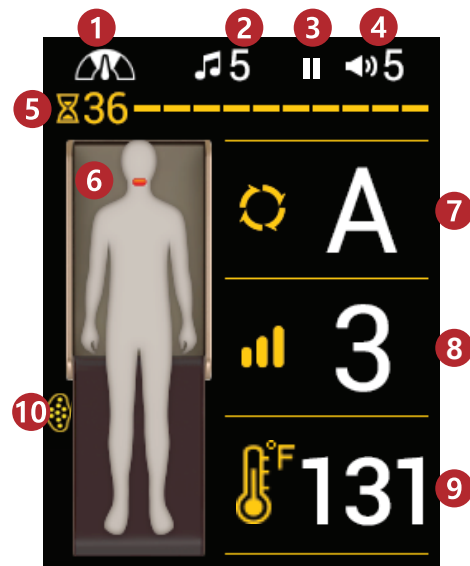

1	Display of speed of the internal projector (low speed/constant speed/high speed)
2	Sound source (Ceragem sound/USB/Bluetooth/Voice guidance)
3	Sound pause
4	Volume (0-20)
5	Time remaining (in minutes)
6	Internal projector location
7	Mode (Automatic mode A,1-16/Intensive/Semi-automatic/Manual)
8	Strength display (1-9)
9	Internal projector temperature (86°F-149°F)
10	Abdominal vibration projector

- Main screen -

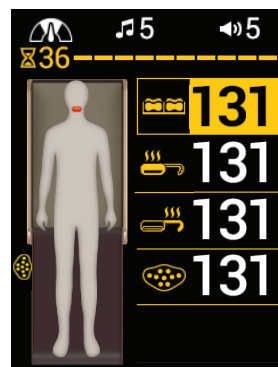

When setting the temperature

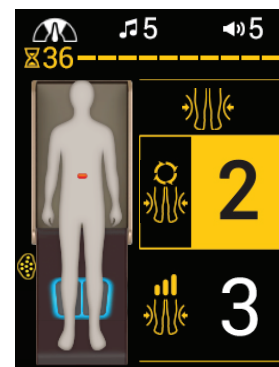

When setting the air massage

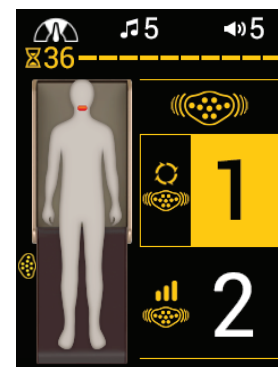

When setting abdominal vibration projector

Wait!

- When the supporting mat is closed, the closed supporting mat image will be displayed as the product image.
- When 10 seconds have passed after the remote control was last operated, the screen will become dark. (When a button is operated, the screen will become bright again.)

3. Using the remote control

Turning on the product



1. Check the cable and the power switch on the main body of the product, and press the power button on the remote control.

- To turn off the remote control, press the power button for approximately 2 seconds.

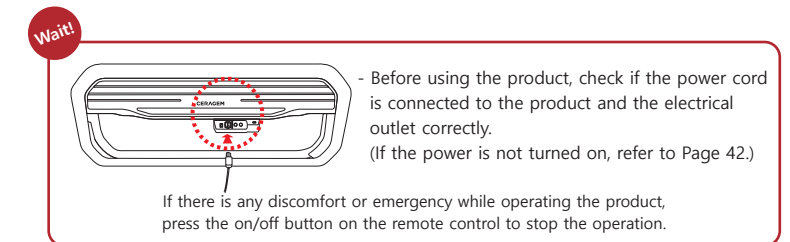

2. The Ceragem logo will appear on the screen of the remote control and the remote control will turn on.

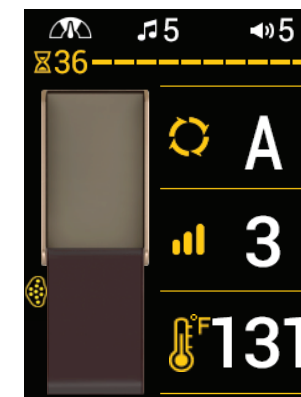

3. When the main screen is displayed, use the product by pressing the desired button.

- The last-used set value will be displayed. (The set value will not be stored if the product is turned off abnormally.)

Wait!

- When the product is closed, the closed product image will be displayed.

3. Using the remote control

Setting the temperature

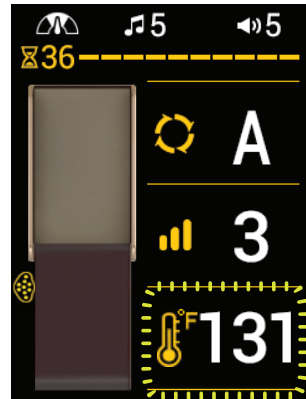

1. Check the current temperature and then press the temperature select button.

- By default, the temperature of the internal projector will be displayed on the screen (as shown).

Wait!

- When the product is closed, the closed product image will be displayed.



2. To cycle through the heating elements and select the desired item, repeatedly click the temperature select button, until the item you'd like to adjust is highlighted in red.

- Temperature selection order: Internal projector→Main mat→Supporting mat→Abdominal vibration projector(3-Sphere projector, etc.)
- The abdominal vibration projector and 3-sphere projector will only be displayed when connected and the position may vary according to the installation order.
- When using No. 13 meditation mode (golf), the temperature of the internal projector can be set between 86°F and 113°F

Internal projector	Main mat	Supporting mat	Abdominal vibration projector	3-Sphere projector (optional product)
Off, 86~149°F			Off, 86~140°F	



3. Upon selecting the desired item, toggle the up/down button to increase/decrease the temperature setting.

- The main screen will be displayed after the temperature adjustment has been recognized.



Caution Low temperature burns may occur, so avoid any direct skin contact with the abdominal vibration projector and 3-sphere projector(optional product) and do not use the product on body parts which are less sensitive or with poor blood circulation (around eyes, neck, armpits, backs of knees, etc.) for a long period of time.

3. Using the remote control

Setting the intensity

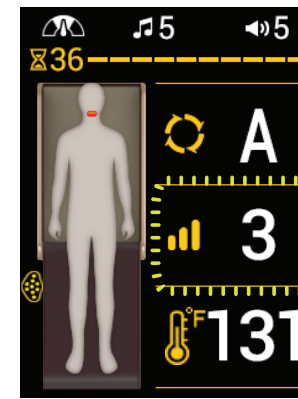

1. Check the current strength and press the strength button.

- The current strength of the internal projector will be displayed on the main screen.

Wait!

- When the product is closed, the closed product image will be displayed.

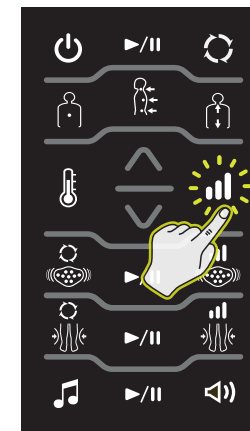

2. Adjust the strength to the desired level by repeatedly clicking the strength button or toggling between the up/down button to increase/decrease the intensity.

- The window containing the strength icon and setting will be highlighted in yellow.

- Strength can be set at Levels 1 ~ 9.

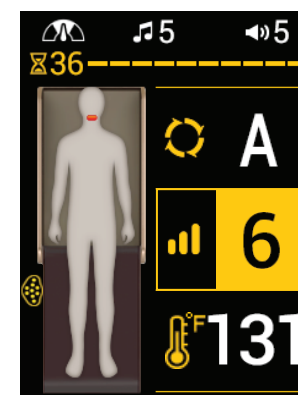

3. Check the changed strength setting on the screen of the remote control.

3. Using the remote control

Setting the internal projector speed

* When using the automatic mode, the internal projector speed will be displayed, allowing you to set the internal projector speed. (speed setting is not available in some modes.)

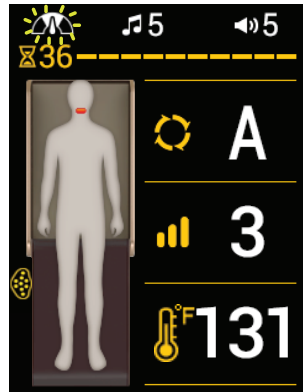

1. Check the speed of the current mode.

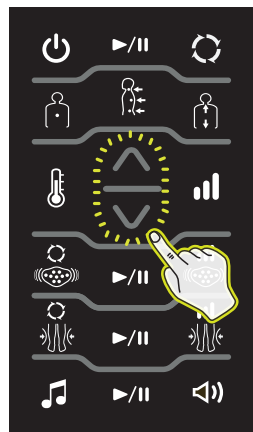

2. Press the up/down button and set the desired speed.

Wait!
- The internal projector speed can be set only from the main screen of the remote control.

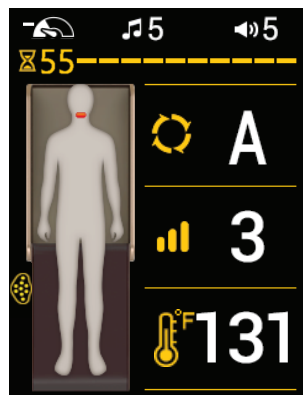

3. Check the changed speed of the mode on the screen of the remote control.

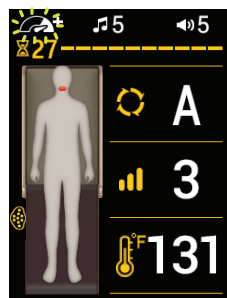

3. Using the remote control

Setting the thermal sofa mode(the supporting mat is closed)



1. When the supporting mat is closed, the device can be operated as a thermal sofa for comfortable seating. The "thermal sofa" icon will be displayed. When the remote control is turned on, check the display.

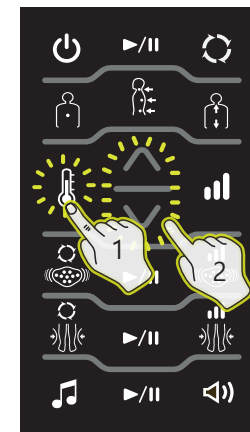

2. To adjust the temperature of the thermal sofa, press the temperature select button until the desired item is highlighted in red, then toggle between the up/down button to increase/decrease the temperature setting.

- When the thermal sofa mode is used, the temperature (preheating) can be adjusted.
- The abdominal vibration projector and 3-sphere projector will only be displayed when connected.
- When a temperature is selected, the image of the relevant item will be displayed in red.

Internal projector	Main mat	Supporting mat	Abdominal vibration projector	3-Sphere projector (optional product)
60 5 5 140 131 131 131	60 5 5 131 140 131 131	60 5 5 131 131 140 131	60 5 5 131 131 131 140	60 5 5 131 131 131 140
Off, 86~149°F			Off, 86~140°F	

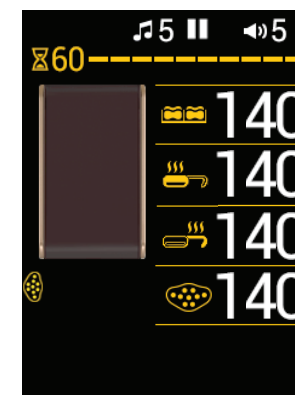

3. After setting the temperature, the current temperature will be displayed.

- If the remote control is operated while using the product, the time remaining will be initialized.

Caution
Low temperature burns may occur, so avoid any direct skin contact with the abdominal vibration projector and 3-sphere projector(optional product) and do not use the product on body parts which are less sensitive or with poor blood circulation (around eyes, neck, armpits, backs of knees, etc.) for a long period of time.

3. Using the remote control

Using the sound

* The user can listen to Ceragem sound stored in the product or preferred sound by connecting an external sound source.

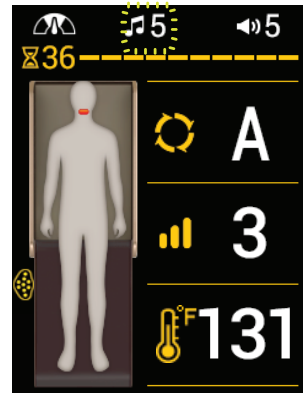

1. Check the current sound status.
 - A sound source will not be played while using the meditation mode.

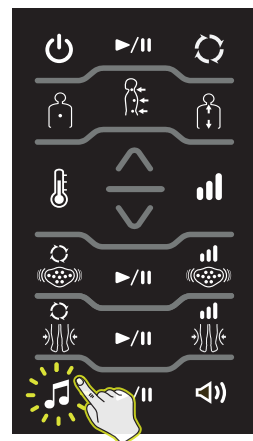

2. To cycle through the audio input, repeatedly press the sound select button until the desired sound source is selected. Cycle through audio tracks by either repeatedly pressing the Play button or the up/down button
 - If a USB is connected but there is no sound source, the icon will not be displayed.
 - If Bluetooth or USB are connected, the corresponding icon will be displayed.
 - Voice guidance will halt if the sound is paused or the volume is set to level 0.

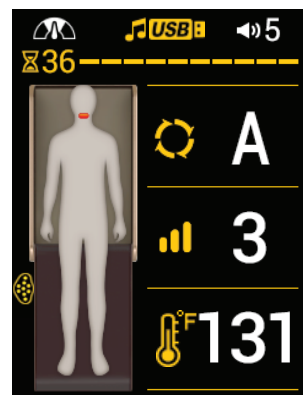
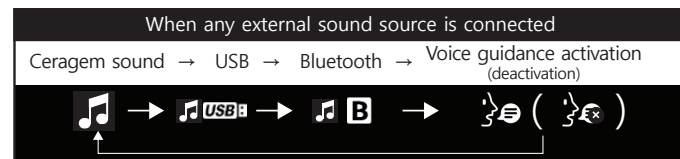

3. Check the changed sound status on the screen of the remote control.
 - File recognition time may be delayed according to the USB specifications or storage capacity.

Wait!

- When the Main mode is paused, the sound will be paused also. The sound will play back when the Sound Start button is pressed again.
- When the sound is paused while using the product, the pause symbol will be displayed.
- Noise may be heard as a result of electromagnetic waves.

3. Using the remote control

Using the volume

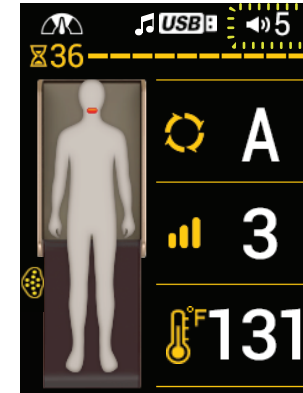

1. Check the current volume status.



2. To adjust the volume, repeatedly press the volume ("speaker" icon) button or toggle between the up/down button to increase/decrease the volume.
 - When setting the sound status, the symbols for the relevant item will be highlighted in yellow, the desired sound and volume may be set at this time.
 - Volume can be set at levels 0~20.
 - The volume of voice guidance can be adjusted using the volume button only when the setting is selected.

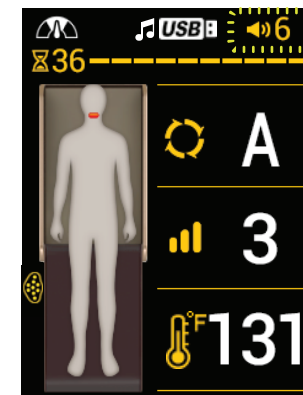

3. Check the changed volume status on the screen of the remote control.

Wait!

- Noise may be heard as a result of electromagnetic waves.

3. Using the remote control

Using the abdominal vibration projector mode

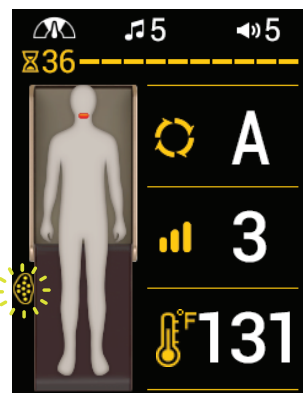

1. Check if the abdominal vibration projector is connected correctly.
 - The current status will be displayed.

Wait!

- When the product is closed, the closed product image will be displayed.

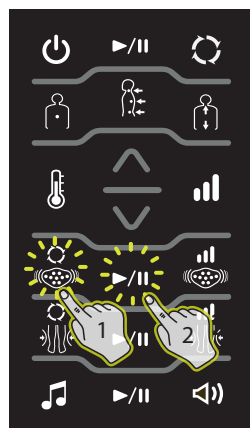

2. To initiate the abdominal vibration projector, click the appropriate icon and press the start/pause button.
 - The mode can be adjusted by clicking on the icon or toggling between the up/down buttons to cycle through modes 1-3.

	Sequential press (Modes 1~3 are selected sequentially)
Mode 1~3	Approximately 18 minutes



- Do not operate the abdominal vibration projector on the floor. (The surface of the product may be damaged.)



3. After setting the mode, operation will start in the selected mode.
 - Shortly after setting is complete, the screen will return to the main screen.

Wait!

- When the Main mode is paused, the abdominal vibration mode will be paused also, and will resume when the abdominal vibration projector start button is pressed.
 - When the abdominal vibration projector mode is paused while using the product, the pause image will be displayed.

3. Using the remote control

Adjusting the abdominal vibration projector strength

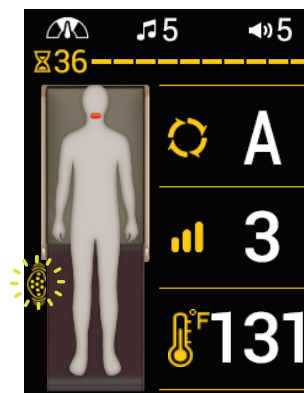

1. Check the screen of the remote control.
 - If properly connected and recognized, the icon will be displayed.

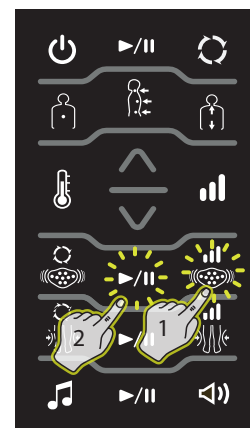

2. Adjust the strength of the abdominal vibration projector by selecting the appropriate icon, then pressing the start/pause button.
 - You can set the desired mode by using the vibration projector strength button or the up/down button while the relevant item is highlighted in yellow.
 - Strength can be set at levels 1~3.



Sequential pressing(Strengths 1-3 are selected sequentially)

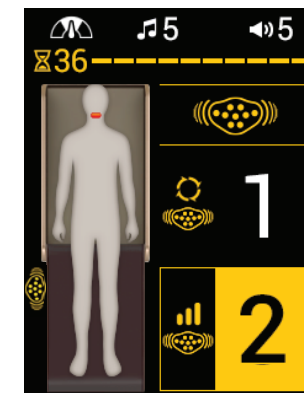

3. After the adjustments are made and recognized, the mode will start at the selected strength.
 - Shortly after the setting is complete, the screen will return to the main screen.



Low temperature burns may occur, so avoid any direct skin contact with the abdominal vibration projector and 3-sphere projector(optional product) and do not use the product on body parts which are less sensitive or with poor blood circulation (around eyes, neck, armpits, backs of knees, etc.) for a long period of time.

3. Using the remote control

Using the air massage mode

* Be sure to use the air cell massager after connecting it to the main body.

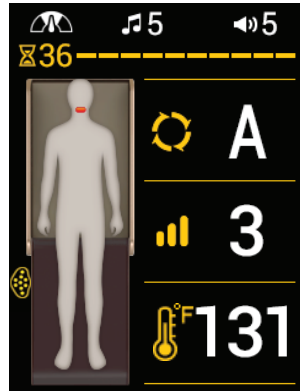

1. Make sure that the air cell massager is connected properly.
 - The current status will be displayed.



Wait!

- When the product is closed, the closed product image will be displayed.
- When using the air cell massage, even if motion sounds (woo~ng, tak tak) of the air pump and solenoid occur, it is not a failure. It is safe to use it.

Caution

- Use the air cell massager after raising the zipper to the end.
- Do not use the product on other areas except for the legs.

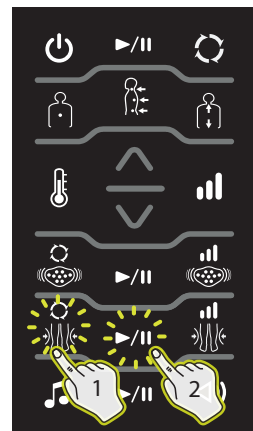

2. Set the mode by pressing the air massage button and press the start/pause button.
 - You can set the desired mode by using the air cell massage button or the up/down button while the relevant item is displayed in yellow.
 - Modes 1-3 can be used.

	Sequential pressing (Modes 1-3 are selected sequentially)
Modes 1-3	Approximately 18 minutes

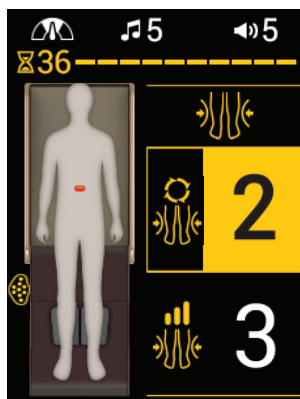

3. After setting the mode, operation will start in the selected mode.
 - Shortly after setting is complete, the screen will return to the main screen.

Wait!

- When the Main mode is paused, the air massage will be paused also, and will not resume when the main massage begins. (It is necessary to re-start the air massage separately.)
- When massage is paused while using the product, the pause image will be displayed.

3. Using the remote control

Using the air massage strength

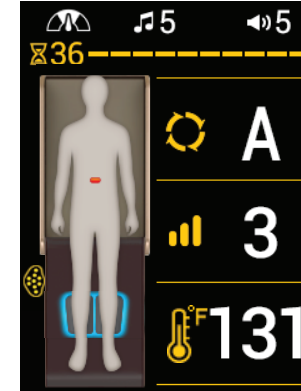

1. Check the screen of the remote control.
 - The current status will be displayed.

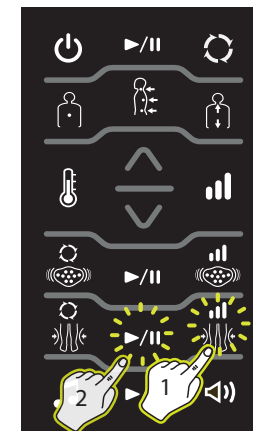

2. Set the strength by pressing the air massage strength button and press the start/pause button.
 - You can set the desired mode by using the air massage strength button or the up/down button while the relevant item is displayed in yellow.
 - Strength can be set at levels 1-9.

	Sequential pressing (Strengths 1-9 are selected sequentially)
--	---------------------------------------------------------------

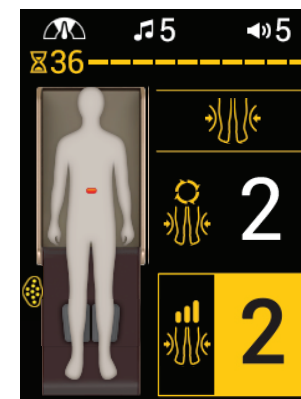

3. After setting is complete, the mode will start at the selected strength.
 - Shortly after setting is complete, the screen will return to the main screen.

3. Using the remote control

Using the automatic mode

* The duration of modes may vary according to the speed of the internal projector.
 * If you press and hold the Mode button, there will be a voice guide on the Mode A (Default) Massage.

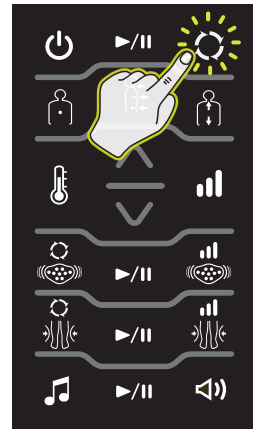

1. Turn on the remote control, check the current status, and press the automatic mode button. (mode and time in case of standard speed)

Mode A (Standard)	Approximately 36 minutes and 30 seconds.		
Mode 1 (Special)	Approximately 75 minutes	Mode 2 (Relax)	Approximately 18 minutes
Mode 3 (Stable)	Approximately 36 minutes and 30 seconds.	Mode 4 (Circulation)	Approximately 36 minutes and 30 seconds.
Mode 5 (Basic health)	Approximately 36 minutes and 30 seconds.	Mode 6 (Energy)	Approximately 36 minutes and 30 seconds.
Mode 7 (Study)	Approximately 36 minutes and 30 seconds.	Mode 8 (Rest)	Approximately 36 minutes and 30 seconds.
Mode 9 (Body line)	Approximately 36 minutes and 30 seconds.	Mode 10 (Stretching)	Approximately 36 minutes and 30 seconds.
Mode 11 (Growth)	Approximately 36 minutes and 30 seconds.	Mode 12 (Meditation - Golf)	Approximately 36 minutes and 30 seconds.
Mode 13 (Meditation - Golf)	Approximately 36 minutes and 30 seconds.	Mode 14 (Meditation - Relax)	Approximately 18 minutes
Mode 15 (Meditation - Stable)	Approximately 36 minutes and 30 seconds.	Mode 16 (Meditation - Breathing)	Approximately 36 minutes and 30 seconds.

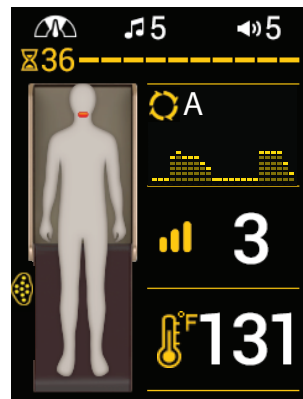

2. Cycle through the modes by repeatedly pressing the automatic mode button until the desired massage program is chosen. Scanning will begin. Remain in the proper body position--supine and relaxed, lying on your back, legs outstretched.

- Massage mode can be chosen either by repeatedly pressing the automatic mode button or by selecting the automatic mode button then toggling between the up/down button while the mode display is highlighted in yellow.
- When the mode begins, the ceragem sound will commence. (A sound source will not be played back while using the meditation mode.)
- The mode cannot be paused during scanning.
- The body type graph varies from person to person.

Sequential pressing (Mode A, 1-16 are selected sequentially)

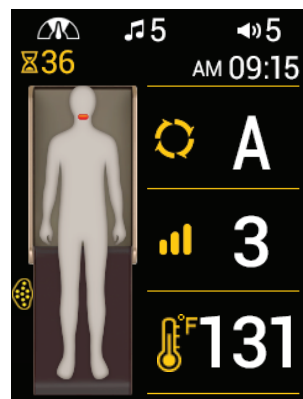

3. Once scanning is completed, the massage program will start. Please remain in the proper position.

- The time remaining will be displayed at the top of the human body icon.

Wait!

- When the product is paused and left the internal projector will move down vertically in order to prevent injury. (When the mode is executed again, the set strength will be restored.)
- When 5 minutes have passed after pausing, the product will turn off automatically.

3. Using the remote control

Using the intensive mode

Duration of mode: Approximately 90 minutes

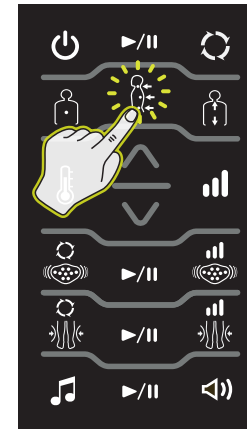

1. Turn on the remote control, check the current status, and press the Intensive mode button.

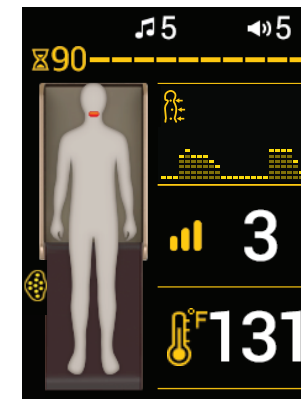

2. When scanning is completed, the intensive mode will begin. Maintain proper body position.

- The time remaining will be displayed at the top of the human body icon.

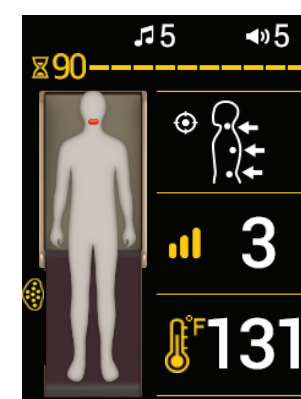

3. To specify the area for intense massage, move the internal projector by holding down on the up/down button until the location is found.

- If you cancel the position setting by pressing the Intensive mode button again, the internal projector will move.
- When 90 minutes have passed after setting the remote control, the remote control will turn off automatically and the mode will end.

Wait!

- When pausing, the internal projector will move down vertically in order to prevent burns and injury. (When the mode is executed again, the set strength will be restored.)
- When 5 minutes have passed after pausing, the product will turn off automatically.

3. Using the remote control

Using the manual mode

Duration of mode Approximately 60 minutes

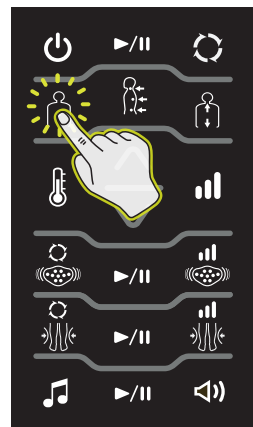

1. Turn on the remote control, check the current status, and press the manual mode button.

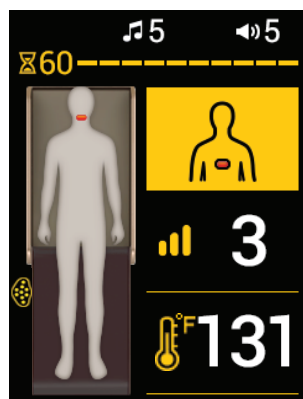

2. Specify the target area for massage by holding down either the up/down buttons until the desired position is found.

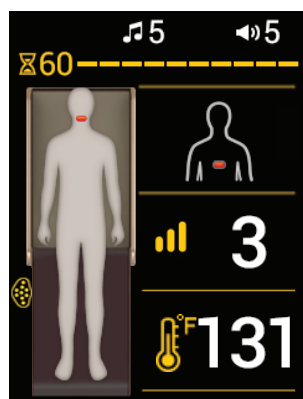

3. The manual mode will begin at the chosen location. Remain in the proper body position.
 - The time remaining will be displayed at the top of the human body icon.
 - If the remote control is operated while using the product, the time remaining will be initialized.
 - When 5 minutes have passed after setting the remote control, the internal projector will move automatically in order to prevent burns.
 - When 60 minutes have passed after setting the remote control, the remote control will turn off automatically and the mode will end.

Wait!

- When pausing, the internal projector will move down vertically in order to prevent burns and injury.
- (When the mode is executed again, the set strength will be restored.)
- When 5 minutes have passed after pausing, the product will turn off automatically.

3. Using the remote control

Using the manual (master) mode

Duration of mode Approximately 60 minutes

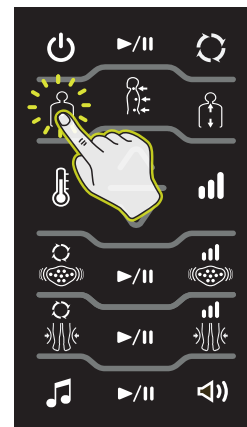

1. Turn on the remote control, check the current status and press the manual mode button twice.

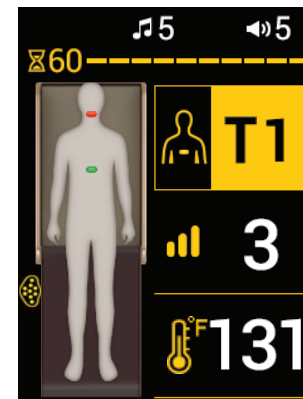

2. Move the internal projector to the desired position using the up/down button.
 - The selected position will be displayed in green.

Position	Screen display (24 segments)
Neck area (cervical spine)	C1~7
Back area (thoracic vertebrae)	T1~12
Waist area (lumbar vertebrae)	L1~5

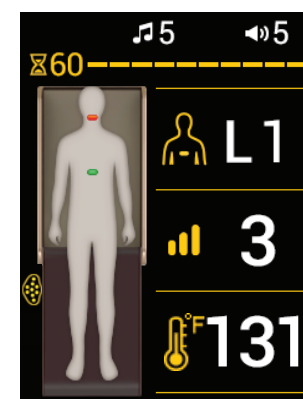

3. Once scanning is complete, the manual master mode will begin. Remain in the proper body position.

- The remaining time is displayed at the upper left corner of the screen. If the remote control is operated while in use, the remaining time is reset.
- When 5 minutes have passed after setting the position, the internal projector will move automatically in order to prevent burns.
- When 60 minutes have passed after operating the remote control, the remote control will turn off automatically and the mode will end.

Wait!

- When pausing, the internal projector will move down vertically in order to prevent burns and injury.
- (When the mode is executed again, the set strength will be restored.)
- When 5 minutes have passed after pausing, the product will turn off automatically.

3. Using the remote control

Using the semi-automatic mode

* In Semi-automatic mode, the internal projector will not move to the cervical spine after the mode ends.

Duration of mode Approximately 60 minutes

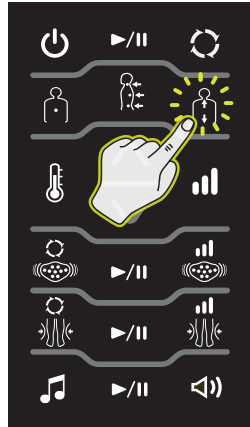

1. Turn on the remote control, check the current status and press the semi-automatic mode button.

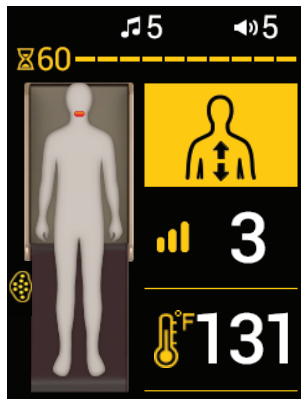

2. Specify the target area for massage by holding down either the up/down buttons until the desired position is found.

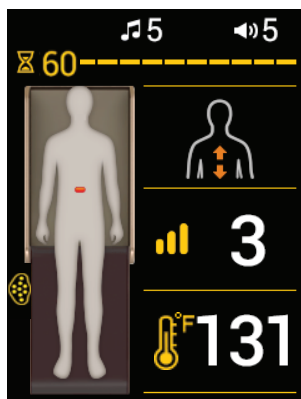

3. The semi-automatic mode will begin at the chosen location. Remain in the proper body position.
 - The remaining time is displayed at the upper left corner of the screen.
 - If the remote control is operated while in use, the remaining time is reset.
 - When 60 minutes have passed after operating the remote control, the remote control will turn off automatically and the mode will end.

Wait!

- When pausing, the internal projector will move down vertically in order to prevent burns and injury. (When the mode is executed again, the set strength will be restored.)
- When 5 minutes have passed after pausing, the product will turn off automatically.

3. Using the remote control

Using the semi-automatic (master) mode

* In Semi-automatic master mode, the internal projector will not move to the cervical spine after the mode ends.

Duration of mode Approximately 60 minutes

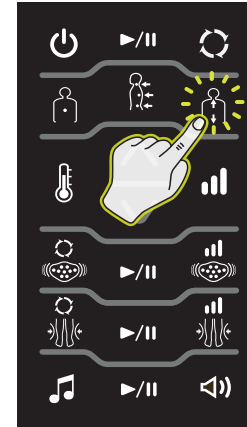

1. Turn on the remote control, check the current status and press the semi-automatic mode button twice.

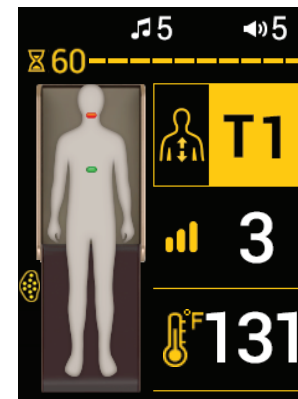

2. Move the internal projector to the desired position using the up/down button.
 - The selected position will be displayed in green.

Position	Screen display (24 segments)
Neck area (cervical spine)	C1~7
Back area (thoracic vertebrae)	T1~12
Waist area (lumbar vertebrae)	L1~5

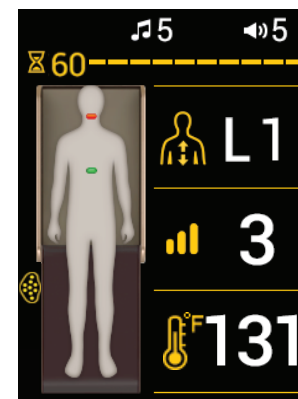

3. Once scanning is complete, the semi-automatic master mode will begin. Remain in the proper body position.
 - The remaining time is displayed at the upper left corner of the screen.
 - If the remote control is operated while in use, the remaining time is reset.
 - When 60 minutes have passed after operating the remote control, the remote control will turn off automatically and the mode will end.

Wait!

- When pausing, the internal projector will move down vertically in order to prevent burns and injury. (When the mode is executed again, the set strength will be restored.)
- When 5 minutes have passed after pausing, the product will turn off automatically.

3. Using the remote control

Changing a product number

- * If there are two or more products in the one space, the device number can be changed as required for use of the product.
- * Devices can be identified and selected by number when connected via bluetooth.

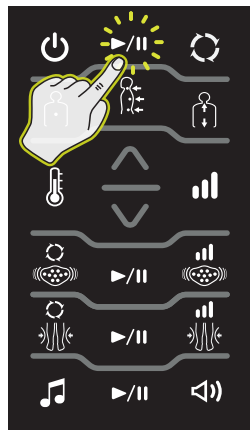

1. Close the supporting mat and press and hold the start/pause button for about 3 seconds.

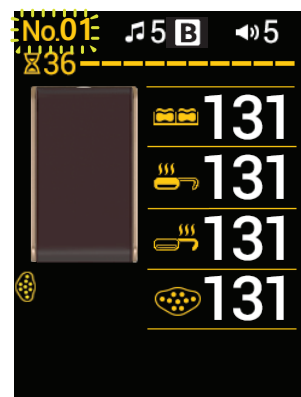

2. The current device number appears on the upper left side of the screen.



3. Change the product number to the desired number using the up/down button.

- The device number will only appear during setting.
- The device number can be set between No. 01-99.

4. Moving the product

1 Close the supporting mat and unplug the cable of the abdominal vibration projector from the main body.

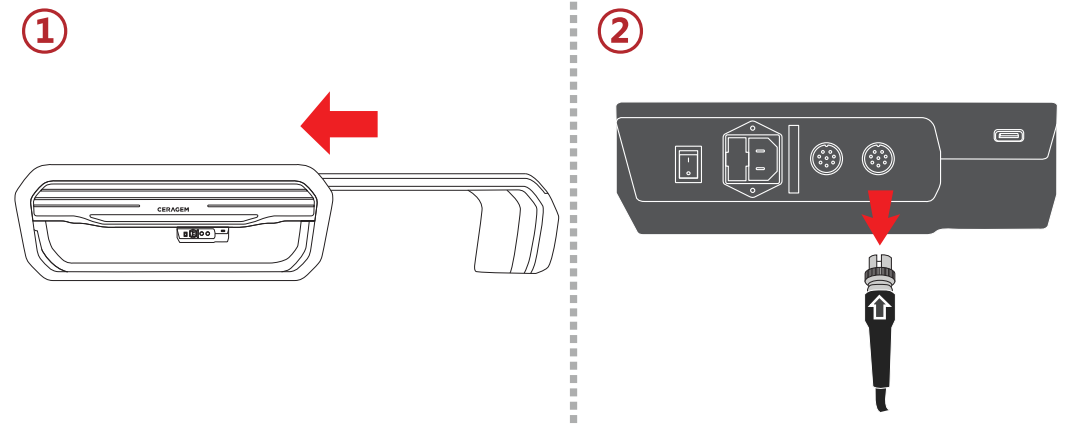

Turn off the remote control after closing the supporting mat.
(If you close the supporting mat after unplugging the power cord, the supporting mat won't be closed completely.)

2

Lift the device from either end, hands placed beneath the main mat. Move to the desired location.

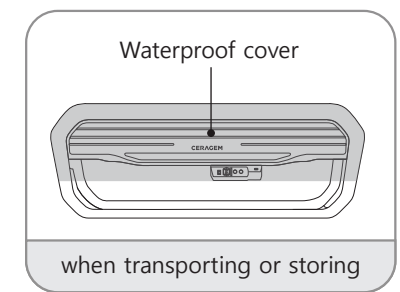
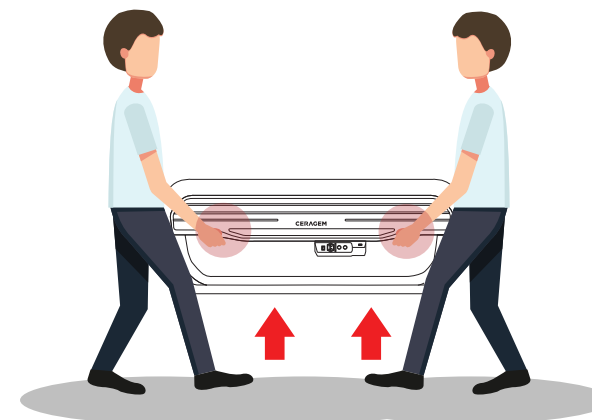

- When lifting the equipment, lift with your legs, not your back to prevent injury.
- Be sure to prevent the supporting mat from opening while moving the product.

MEMO

IV. Maintenance and troubleshooting

1. User Checklist
(Before & After use procedure)
2. Maintenance and storage
3. Troubleshooting
4. Diagnostic codes
5. Product specifications

1. User checklist (Before & After use procedure)

Inspection points before use

1. Is the power cord connected to the socket?
2. Did you check whether the main body's power button is "ON"?
3. Is the remote control power and the LCD screen "ON"?
4. Did you check whether the projector's temperature has been set to the appropriate level?
5. Is there anything strange about the abdominal vibration projector?
6. Did you check whether there is no damage to the projector cover?

Inspection points after use

1. Have the remote control and LCD screen been turned "OFF"?
2. Did you check whether main body's power button is "OFF"?
3. Is the power cord disconnected from the socket?

1. User checklist

Self-diagnosis guide



Classification	Symptom	Description
Shape of the product	⊙ The hip section on the main mat droops significantly.	☞ The mat cover and fabric on the CERAGEM Master are made of material that extends according to the curve and weight of the body, avoiding disruption of the massage as much as possible. Therefore, it is natural that the hip section which is the heaviest part of human body, droops in the event of continuous use at home.
Sounds from the product	⊙ Some noise will be heard when the internal projector operates. Such noises are louder than the noise I heard from the product in the store.	☞ The internal projector moves vertically and horizontally using two motors, so, naturally, it makes some noise. You may think that the motor sounds are louder when you use the product at home than when you tried the product at a store. This is often a result of the subsequent lack of ambient surrounding store noise.
Smell	⊙ The product may have a chemical-like smell.	☞ It is a new product, so it may smell temporarily. Such a smell is not harmful to the human body at all and it will disappear soon once the product is in use.
Auxiliary parts	⊙ A loud sound occurs when I spread the supporting mat.	☞ It is a normal operating noise that occurs in adjusting the height of the supporting mat to the height of the main body when the supporting mat is opened. Such a sound can be reduced if you open the supporting mat slowly.
Remote control	⊙ After using the remote control, the cable cannot be retracted back inside.	☞ Check if the remote control cable is twisted or jammed in the middle. When the cable is pulled excessively, the size of curled part in the cable increases, so the cable may not be retracted back inside temporarily. But, it will return to its normal condition with the passage of time.
Air massage	⊙ The air massager starts pressing the thighs first.	☞ Check if the air massager is connected correctly. If it is connected in reverse, the massage may begin from the thighs first.

2. Maintenance and Storage

1 Exterior of the product is a petroleum-based product and should not be exposed to organic solvents such as acetone, ballpoint pen, gasoline, thinner, sweat, hair mousse or hair spray.

2 Where there is direct contact with the head or skin, wipe with a dry cloth.

3 If there is contact with cosmetic products or volatile emulsions and is left for a long time, the surface may peel off so wipe with a dry cloth as soon as.

4 When washing outer fabric, make sure to hand wash separately with a neutral detergent.

5 If there is contact with hot objects or heat, the leather will curl up so please use caution.

6 Avoid wearing clothes that may cause stains when using the product. (Please be careful as there is a risk of contamination caused by external friction.)

7 Avoid direct sunlight and humidity and store at room temperature. (It causes discoloration and aging of the product.)

8 Please do not twist the remote control cable.

3. Troubleshooting

Does the remote control turn on?

Q : Is the power cord connected properly? A : Connect the power cord again.

Q : Is the power switch on the bottom of the product on? A : Turn on the power switch.

The the abdominal vibration projector do not operate.

Q : Are the abdominal vibration projector connected properly? A : Connect the abdominal vibration projector properly.

Is the product malfunctioning?

Q : Can you move the internal projectors using the up/down key? A : Internal projectors can be moved using the up/down key only in intensive mode, semi-automatic mode, manual mode.

Q : Can some of the remote control keys be operated? A : Check the condition of the supporting mat. Some of the remote control keys cannot be operated if the supporting mat is not completely opened.

Q : Is the supporting mat fully closed? A : Make sure the power cord is plugged in. Make sure the remote control is powered on.

Is the air massage mode not working?

Q : Is the air hose not twist or fold? A : Be careful not to twist or fold the air hose.

Are the diagnosis code messages displayed on the remote control?

Q : Are the diagnosis code messages displayed on the remote control? A : After checking the diagnosis code messages, contact the customer support center. Never dismantle the product arbitrarily.

Why is the USB not recognized?

Q : Is a sound source in a USB device not playing back? A : It takes time for the product to recognize a USB device. Check if it is connected correctly, wait, and try again.

A : Is there a playable sound source stored in USB? Please check.

Customer Support Center
CERAGEM INTERNATIONAL INC.
LOS ANGELES, CA 90010
3699 WILSHIRE BLVD. STE 930
213-480-7070

3. Diagnostic codes

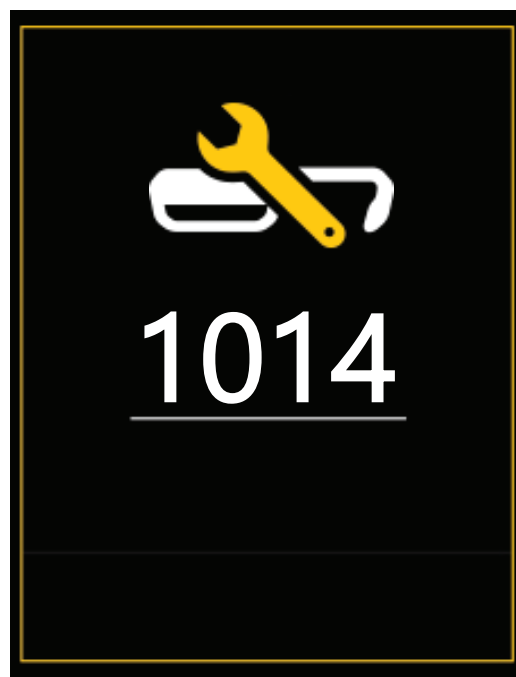

Wait !

Make sure to note down the 4-digit code and to contact the customer center in case the following message appears on the remote control while using the product:

 **Danger** Notify Ceragem and the relevant organization (agency) in case of injury, accident (fire, personal injury, etc.) while using the product.

 **Caution** When a diagnostic codes is displayed, check the message and contact the Customer Service Center.

5. Product specifications

Model	CGM MB-1701
Article	Automatic Thermal Massager
Rated Voltage	100-127V~, 50/60 Hz
Power Consumption	480 VA
Environment temperature	50°F~104°F
Recommended height for body sensing	47.2 in – 73.2 in
Playable files	MP3, WAV
USB format type	FAT, FAT32
Measurements	Fully opened: 28.7in X80.5inX17.0in(±0.4in) Folded: 28.7inX47.7inX17.0in(±0.4in)
Maximum Permissible Weight	298lbs
Weight (Including box)	162 lbs±6 lbs
Manufacturer	CERAGEM Co., Ltd.

- * This product is a medical device.
- * Please be advised that since this product was manufactured for domestic use, no after-service will be available when used abroad.
- * Due to constant quality improvement, design and specifications of the product are subject to change without notice.
- * Expected service life: 9 years.
- * Connection to wireless communication may be limited due to the distance between devices (speed), obstacles or other wireless devices.

Wait !

Warranty details can be found on www.ceragemus.com.
Please register your product on www.ceragemus.com immediately following purchase for warranty services.

MEMO

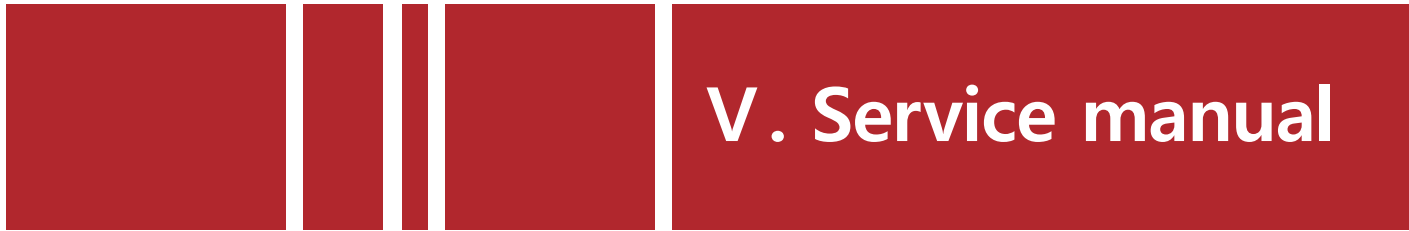

V. Service manual

1. Explanation of mark, delivery, and storage
2. Attached documents

1. Explanation of mark, delivery, and storage

Classification



Form of electric shock protection	CLASS II EQUIPMENT
Degree of electric shock protection	TYPE BF APPLIED PART.
Degree of protection from harmful invasion of water	Ordinary
Depending on the mode of operation	Continuous operation.











 This marking shown on the product or its literature, indicates that it should not be disposed with other household wastes at the end of its working life. To prevent possible harm to the environment or human health from uncontrolled waste disposal, please separate this from other types of wastes and recycle it responsibly to promote the sustainable reuse of material resources. Household users should contact either the retailer where they purchased this product, or their local government office, for details of where and how they can take this item for environmentally safe recycling.

Disposal of Old Electrical & Electronic Equipment
Applicable in the European Union and other European countries with separate collection systems.

 Medical -General Medical Equipment
E358148
AS TO ELECTRICAL SHOCK,
FIRE AND MECHANICAL HAZARDS ONLY IN ACCORDANCE WITH : UL Classification Mark
(ANSI/AAMI ES60601-1 (2005)AMD 1(2012),
CAN/CSA C22.2 NO. 60601-1:14(2014), IEC 60601-1-11 (2015)

V~ : AC (alternating current) voltage source
I : On (power: connectino to the mains) O : Off (power: disconnection from the mains)

 -68°F to 140°F Transport and storage ambient temperature range
 500hpa to 1060hpa Transport and storage atmospheric pressure range
 10% to 95% Transport and storage relative humidity range

 TYPE BF APPLIED PART	 CLASS II EQUIPMENT
 This way up	 Keep dry
 Use no hooks	 Fragile (handle with care)
 Manufacturer	 Manufacturing date
SN Serial number	 Refer to instruction manual/booklet sign
 General prohibition sign	REF Catalogue number
IP20 The product's IP classification	IP21 When 'waterproof cover' cover to the product
MD Medical device	UDI Unique device identifier
 Country of manufacture	# Model number

The disposal of waste products / residues, etc.
Business users should contact CERAGEM and check the terms and conditions of the purchase contract. This product should not be mixed with other commercial wastes for disposal.

Condition for Transport and Storage
a) An ambient temperature range of -20°C(-68°F) to +60°C(+140°F).
b) A relative humidity range of 10% to 95%.
c) An atmospheric pressure range of 500hPa to 1060hPa

Condition for Operation
a) An ambient temperature range of +10°C(+50°F) to +40°C(+104°F).
b) A relative humidity range of 30% to 75%.
c) An atmospheric pressure range of 700hPa to 1060hPa

Do not disassemble and contact the customer service center when problem occurs with a fuse.

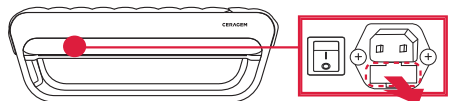
 Capacity of a fuse : AC 250V, T10AL
Time-Lag, 10A, Low breaking Capacity(Glass Body Fuse)

* Pull the marked area to exchange the fuse (related to service engineer)
* The equipment has to be installed at place built protective device having appropriate breaking capacity so that prospect short-circuit current do not exceed 40 A .

2. Attached documents

Guidance and manufacturer's declaration - electromagnetic emission

The Model CGM MB-1701(CERAGEM CO., LTD. Automatic Thermal Massager)is intended for use in the electromagnetic environment specified below.The customer or the user of CGM MB-1701 should assure that it is used in such an environment.

Emission test	Compliance	Electromagnetic environment - guidance
RF emissions CISPR 11	Group 1	The Model CGM MB-1701 uses RF energy only for its internal function. Therefore. Its RF emissions are very low and are not likely to cause any interference in nearby electronic equipment
	Class B	The Model CGM MB-1701 is suitable for use in all establishments, including domestic establishments and those directly connected to the public low-voltage power supply network that supplies buildings used for domestic purposes.
Harmonics emission IEC 61000-3-2	A	
Voltage fluctuation IEC 61000-3-3	Complies	

2. Attached documents

Manufacturer's declaration - electromagnetic immunity

The CGM MB-1701 is intended for use in the electromagnetic environment specified below. The customer or the user of CGM MB-1701 should assure that it is used in such an environment.

Immunity test	IEC 60601 test level	Compliance level	Electromagnetic environment - guidance
Electrostatic discharge (ESD) IEC 61000-4-2	8kV Contact 15kV Air	8kV Contact 15kV Air	Floors should be wood, concrete or ceramic tile. If floors are covered with synthetic material, the relative humidity should be at least 30%.
Electrical fast Transient/burst IEC 61000-4-4	2kV for power supply lines 1kV for input/output lines	2kV for power supply lines 1kV for input/output lines	The main power's quality should be that of a typical commercial or hospital environment.
Surge IEC 61000-4-5	1kV differential mode 2kV common mode	1kV differential mode 2kV common mode	The main power's quality should be that of a typical commercial or hospital environment.
Power frequency (50 or 60Hz) Magnetic field IEC 61000-4-8	30 A/m	30 A/m	Power frequency magnetic fields should be at levels characteristic of a typical location in a typical commercial or hospital environment.
Voltage dips, short Interruptions and Voltage variations on power supply input lines IEC 61000-4-11	0% U _T (100% dip in U _T) for 0.5 cycle 0% U _T (100% dip in U _T) for 5 cycle 70% U _T (30% dip in U _T) for 25 cycle 0% U _T (100% dip in U _T) for 5 s	0% U _T (100% dip in U _T) for 0.5 cycle 0% U _T (100% dip in U _T) for 5 cycle 70% U _T (30% dip in U _T) for 25 cycle 0% U _T 100% dip in U _T for 5 s	The main power's quality should be that of a typical commercial or hospital environment. If the user of the CGM MB-1701 requires continued operation during power mains interruptions, it is recommended that the CGM MB-1701 be powered from an uninterruptible power supply or a battery.

Note : U_T is the a.c. mains voltage prior to application of the test level.

2. Attached documents

The CGM MB-1701 is intended for use in the electromagnetic environment specified below. The customer or the user of CGM MB-1701 should assure that it is used in such an environment.

Immunity test	IEC 60601 test level	Compliance level	Electromagnetic environment - guidance
Conducted RF IEC 61000-4-6	3 Vrms 150 kHz to 80 MHz	3 Vrms 150 kHz to 80 MHz	Portable and mobile RF communications equipment should be used no closer to any part of the CGM MB-1701, including cables, than the recommended separation distance calculated from the equation applicable to the frequency of the transmitter. Recommended separation distance $d = \left[\frac{3,5}{V_1} \right] \sqrt{P}$
Radiated RF IEC 61000-4-3	3 V/m 80.0 MHz to 2.7 GHz	3 V/m 80.0 MHz to 2.7 GHz	Recommended separation distance $d = \left[\frac{3,5}{E_1} \right] \sqrt{P} \quad 80\text{MHz bis } 800 \text{ MHz}$ $d = \left[\frac{7}{E_1} \right] \sqrt{P} \quad 800\text{MHz bis } 2.5 \text{ GHz}$ Where P is the maximum output power rating of the transmitter in watts (W) according to the transmitter manufacturer and d is the recommended separation distance in meters(m). Field strengths from fixed RF transmitters, as determined by an electromagnetic site survey, (a) Should be less than the compliance level in each frequency range (b). Interference may occur in the vicinity of equipment marked with the following symbol: 

Note 1) U_T is the A.C. mains voltage prior to application of the level.

Note 2) At 80 MHz and 800 MHz, the higher frequency range applies.

Note 3) These guidelines may not apply in all situations. Electromagnetic propagation is affected by absorption and reflection from structures, objects and people.

a Field strengths from fixed transmitters, such as base stations for radio (cellular/cordless) telephones and land mobile radios, amateur radio, AM and FM radio broadcast and TV broadcast cannot be predicted theoretically with accuracy.

To assess the electromagnetic environment due to fixed RF transmitters, an electromagnetic site survey should be considered. If the measured field strength in the location in which the EUT is used exceeds the applicable RF compliance level above, the EUT should be observed to verify normal operation. If abnormal performance is observed, additional measures may be necessary, such as re-orienting or relocating the EUT.

b Over the frequency range 150 kHz to 80 MHz, field strengths should be less than [V 1] V/m.

2. Attached documents

Recommended separation distances between portable and mobile RF communications equipment and the CGM MB-1701.

The CGM MB-1701 is intended for use in an electromagnetic environment in which radiated RF disturbances are controlled. The user of the CGM MB-1701 can help prevent electromagnetic interference by maintaining a minimum distance between portable and mobile RF communications equipment (transmitters) and the CGM MB-1701 as recommended below, according to the maximum output power of the communications equipment.

Rated maximum output power (W) of transmitter	Separation distance (m) according to frequency of transmitter		
	150 kHz to 80 MHz	80 MHz to 800 MHz	800 MHz to 2.7 GHz
0.01	0.12	0.04	0.07
0.1	0.37	0.11	0.22
1	1.17	0.35	0.70
10	3.70	1.11	2.21
100	11.70	3.50	7.00

For transmitters rated at a maximum output power not listed above, the recommended separation distance (d) in meters (m) can be estimated using the equation applicable to the frequency of the transmitter, where P is the maximum output power rating of the transmitter in watts (W) according to the transmitter manufacturer.

Note 1: At 80 MHz and 800 MHz, the separation distance for the higher frequency range applies
 Note 2: These guidelines may not apply in all situations. Electromagnetic propagation is affected by absorption and reflection from structures, objects, and people.

Immunity and Compliance Level			
Immunity test	IEC 60601 test level	Actual immunity level	Compliance level
Conducted RF IEC 61000 -4-6	3 Vrms , 150 kHz to 80 MHz	3 Vrms , 150 kHz to 80 MHz	3 Vrms , 150 kHz to 80 MHz
Radiated RF IEC 61000 -4-3	10 V/m, 80 MHz to 2.5 GHz	3 V/m, 80 MHz to 2.7 GHz	3 V/m, 80 MHz to 2.7 GHz

2. Attached documents

Manufacturer's declaration - electromagnetic immunity

The CGM MB-1701 is intended for use in the electromagnetic environment specified below. The customer or the user of CGM MB-1701 should assure that it is used in such an environment.

Immunity test	IEC 60601 Test level	Compliance level	Electromagnetic environment - guidance
Conducted RF IEC 61000-4-6	3 Vrms 150 kHz to 80 MHz	3 Vrms 150 kHz to 80 MHz	CGM MB-1701 must be used only in a shielded location with a minimum RF shielding effectiveness and, for each cable that enters the shielded location with a minimum RF shielding effectiveness and, for each cable that enters the shielded location.
Radiated RF IEC 61000-4-3	3 V/m 80.0 MHz to 2.7 GHz	3 V/m 80.0 MHz to 2.7 GHz	Field strengths outside the shielded location from fixed RF transmitters, as determined by an electromagnetic site survey, should be less than 10V/m.a Interference may occur in the vicinity of equipment marked with the following symbol: 

Note 1) These guidelines may not apply in all situations. Electromagnetic propagation is affected by absorption and reflection from structures, objects and people.

Note 2) It is essential that the actual shielding effectiveness and filter attenuation of the shielded location be verified to assure that they meet the minimum specification.

a Field strengths from fixed transmitters, such as base stations for radio (cellular/cordless) telephones and land mobile radios, amateur radio, AM and FM radio broadcast and TV broadcast cannot be predicted theoretically with accuracy.

To assess the electromagnetic environment due to fixed RF transmitters, an electromagnetic site survey should be considered. If the measured field strength in the location in which the EUT is used exceeds the applicable RF compliance level above, the EUT should be observed to verify normal operation. If abnormal performance is observed, additional measures may be necessary, such as re-orienting or relocating the EUT.

b Over the frequency range 150 kHz to 80 MHz, field strengths should be less than [V 1] V/m.